



Installation Instructions for IUP007F
Nissan Navara D40
Underbody Protection Plate

Fuel Tank



NISSAN Navara (D40; 2,5)

2005



IUP007F

1/7



Location/Position Arrow

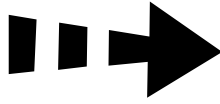

Movement Arrow



Screw Arrow

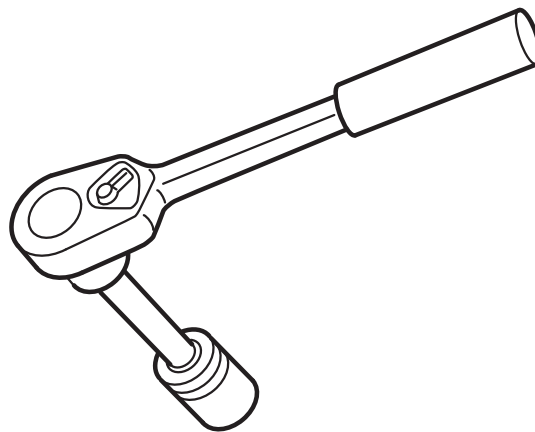
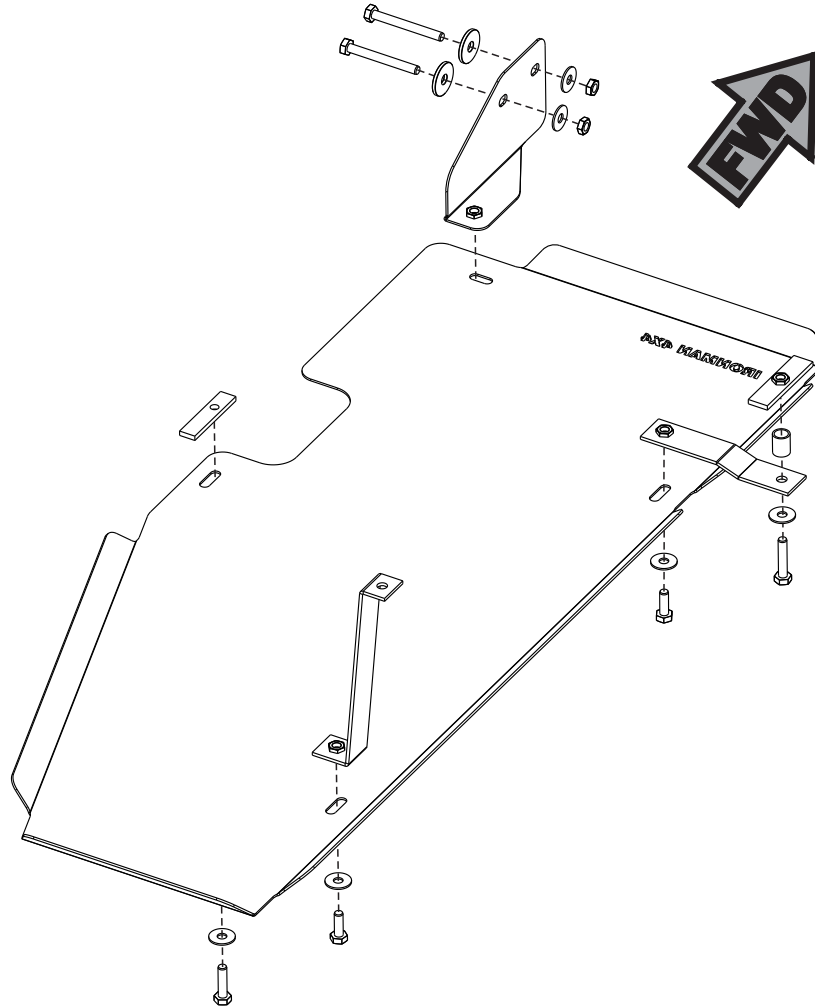

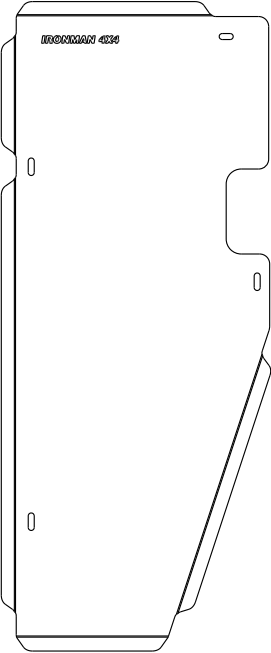
<p>A</p>	 <p style="text-align: right;">1X</p>
-----------------	--

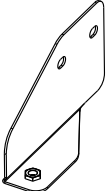
<p>B</p>	 <p style="text-align: right;">1X</p>
-----------------	---

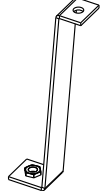
<p>C</p>	 <p style="text-align: right;">1X</p>
-----------------	---

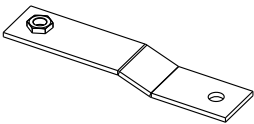
<p>D</p>	 <p style="text-align: right;">1X</p>
-----------------	---

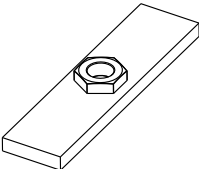
<p>E</p>	 <p style="text-align: right;">1X</p>
-----------------	--

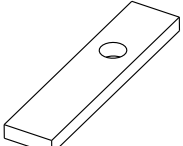
<p>F</p>	 <p style="text-align: right;">1X</p>
-----------------	--

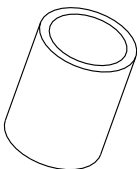
<p>G</p>	 <p style="text-align: right;">1X</p>
-----------------	--

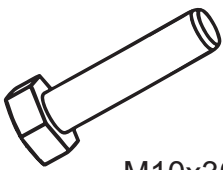
<p>H1</p>	 <p>M10x30 3X</p>
------------------	---

<p>H2</p>	 <p>M10x40 1X</p>
------------------	---

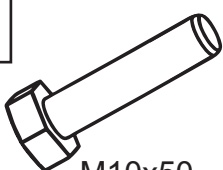
<p>H3</p>	 <p>M10x50 1X</p>
------------------	---

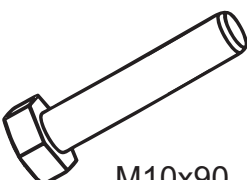
<p>H4</p>	 <p>M10x90 2X</p>
------------------	---

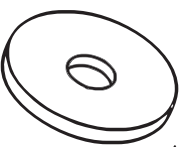
<p>I</p>	 <p>∅10 7X</p>
-----------------	--

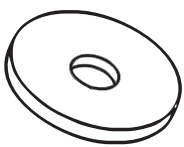
<p>J</p>	 <p>Unique washer 2X</p>
-----------------	--

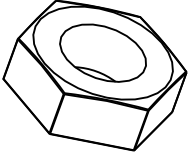
<p>K</p>	 <p style="text-align: right;">M10 2X</p>
-----------------	---

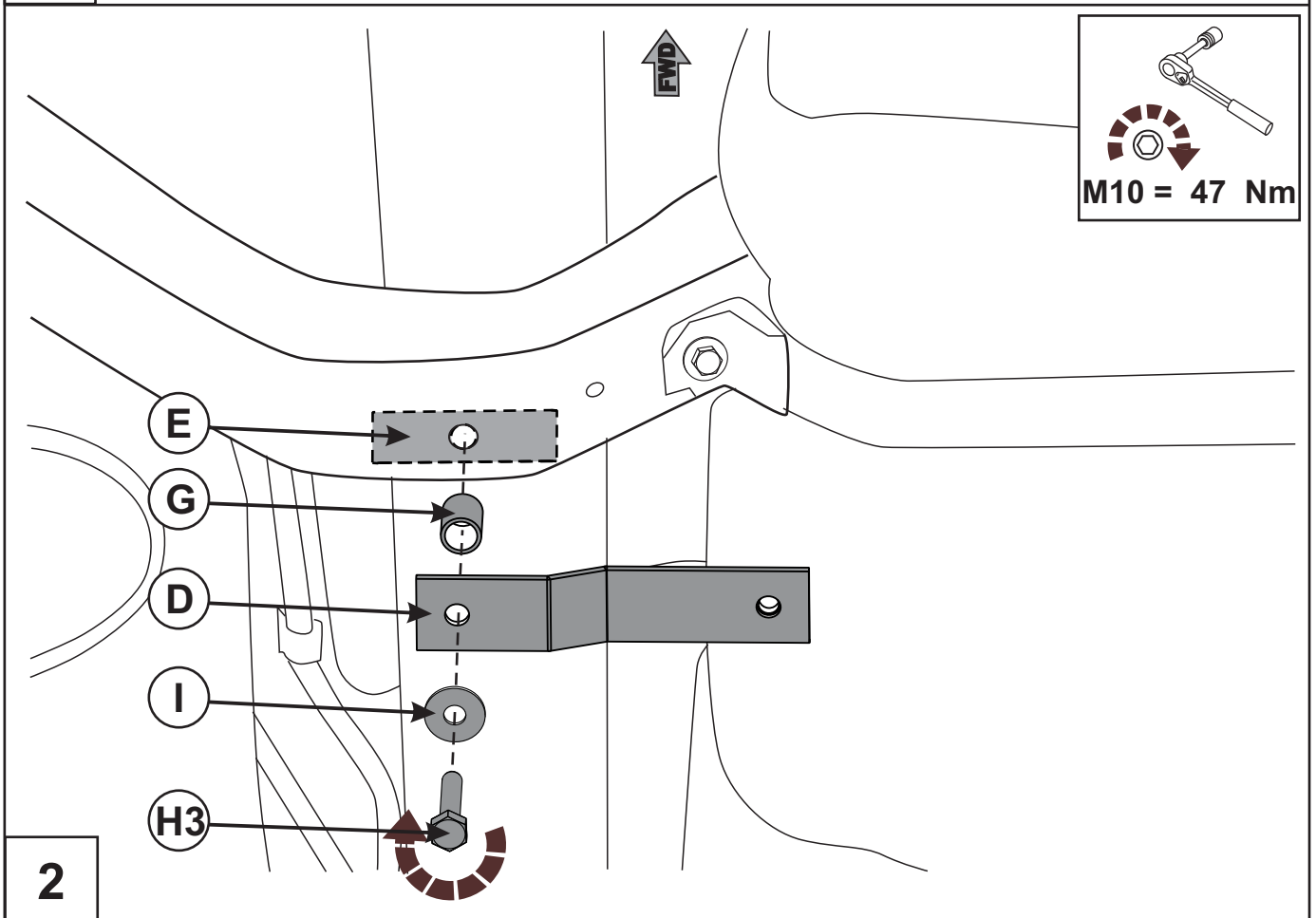
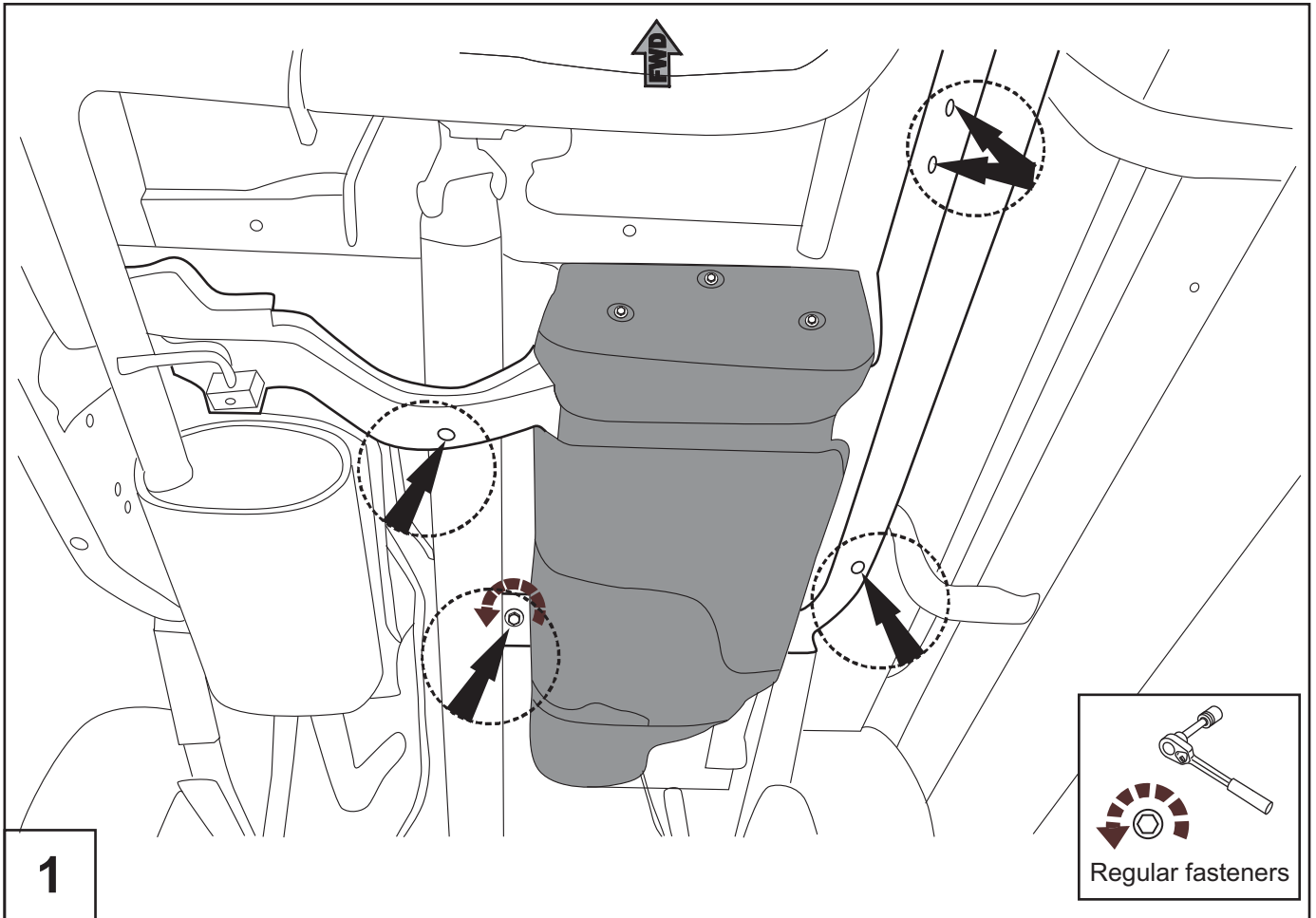

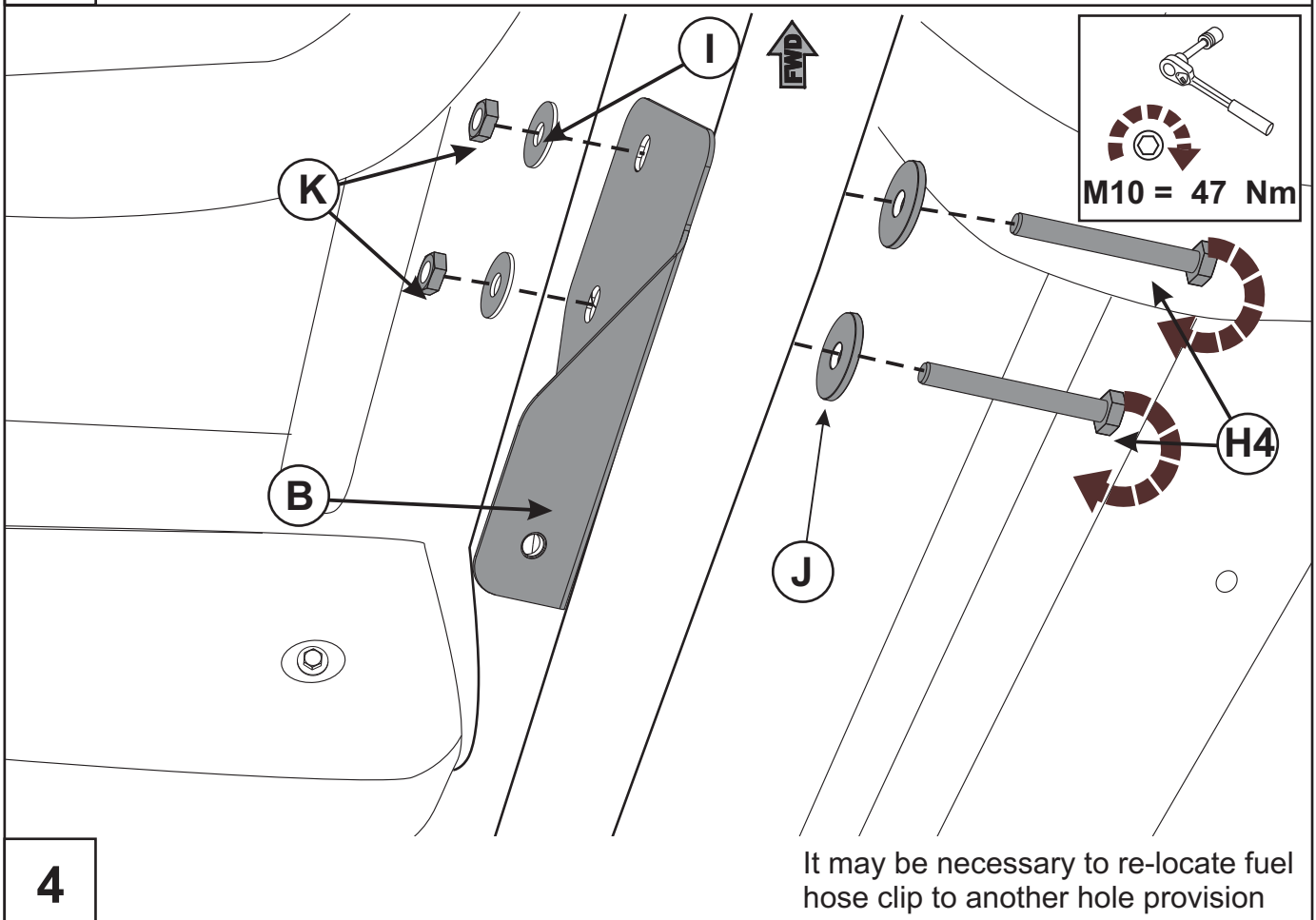
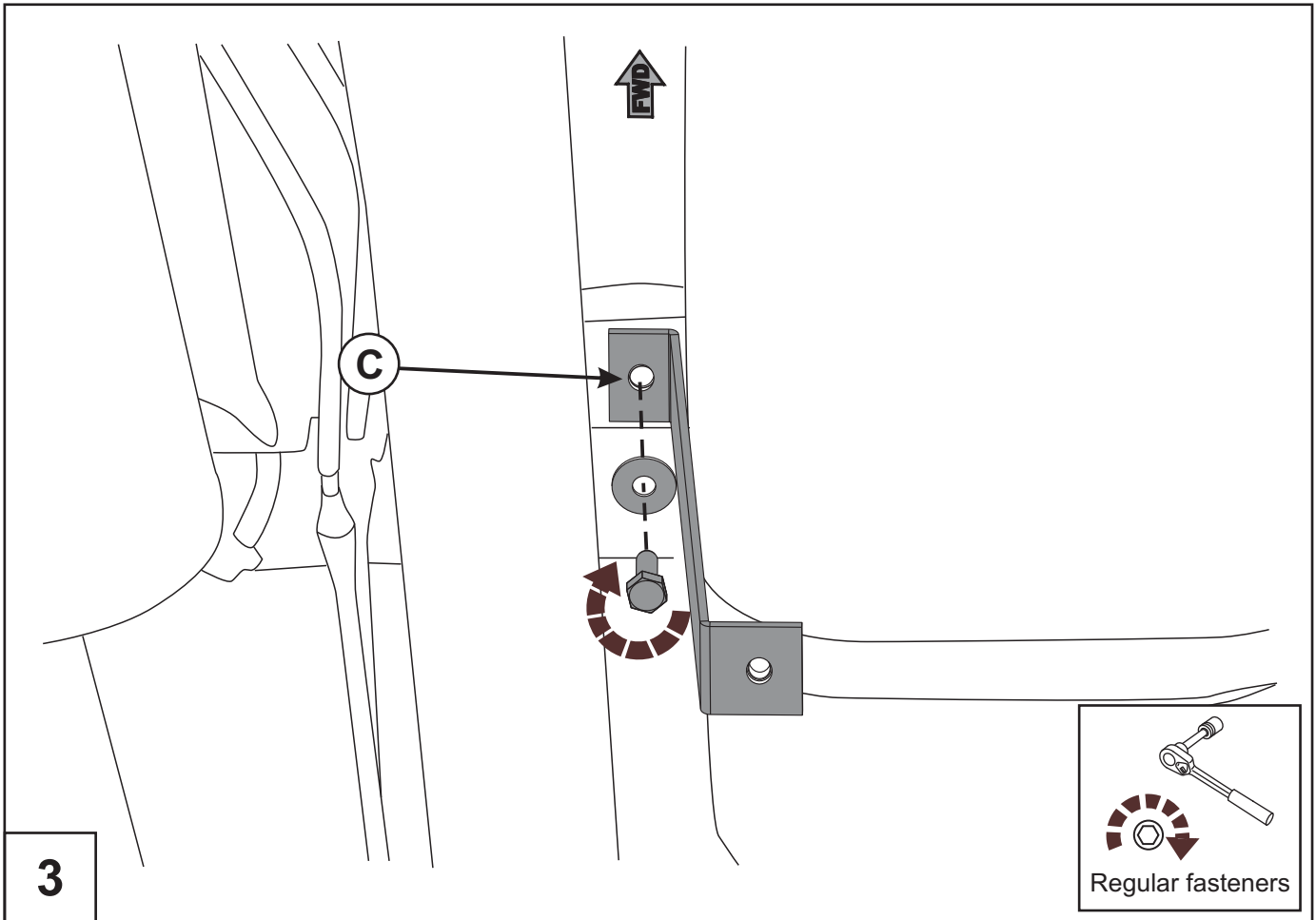

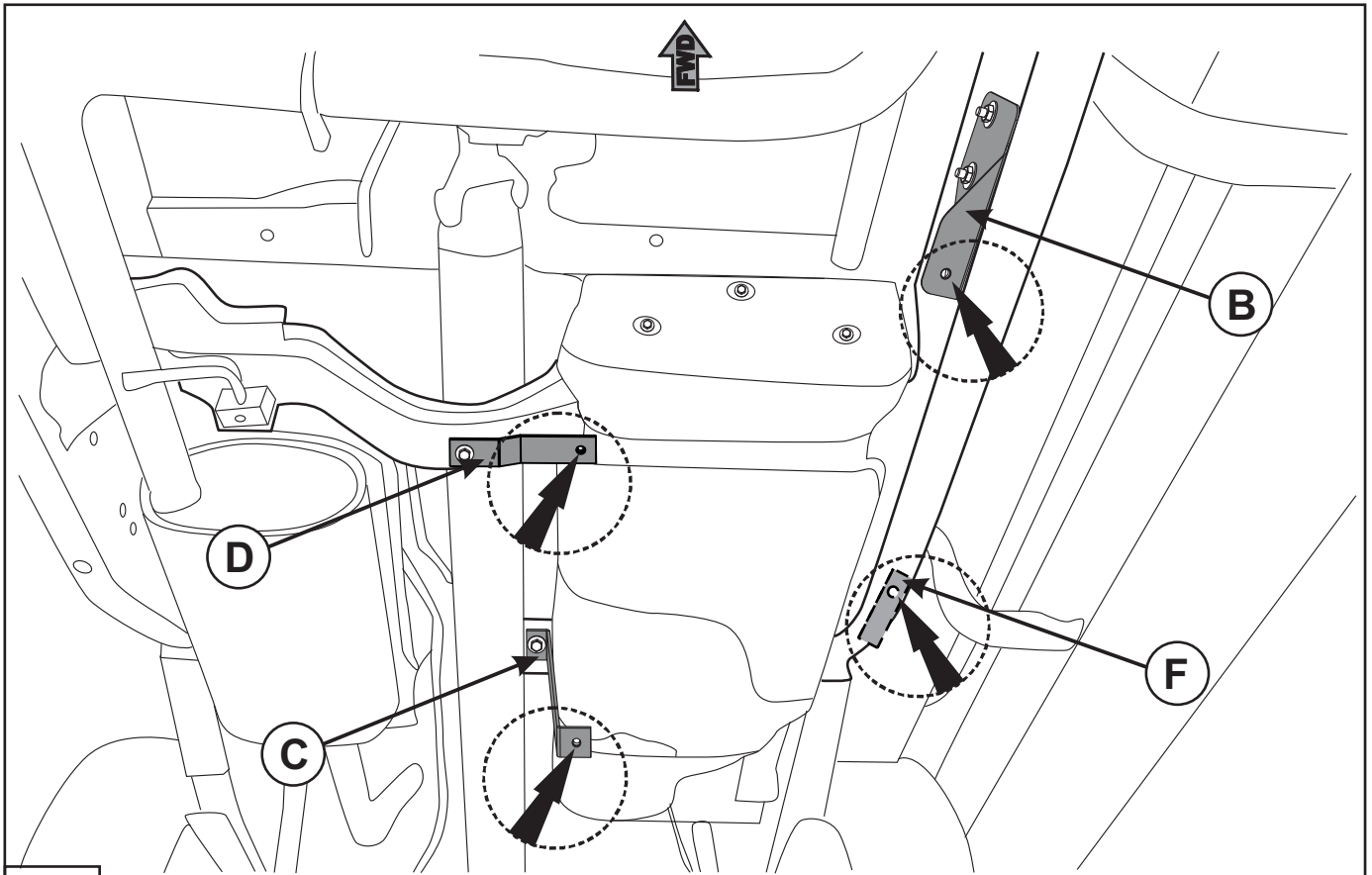

5

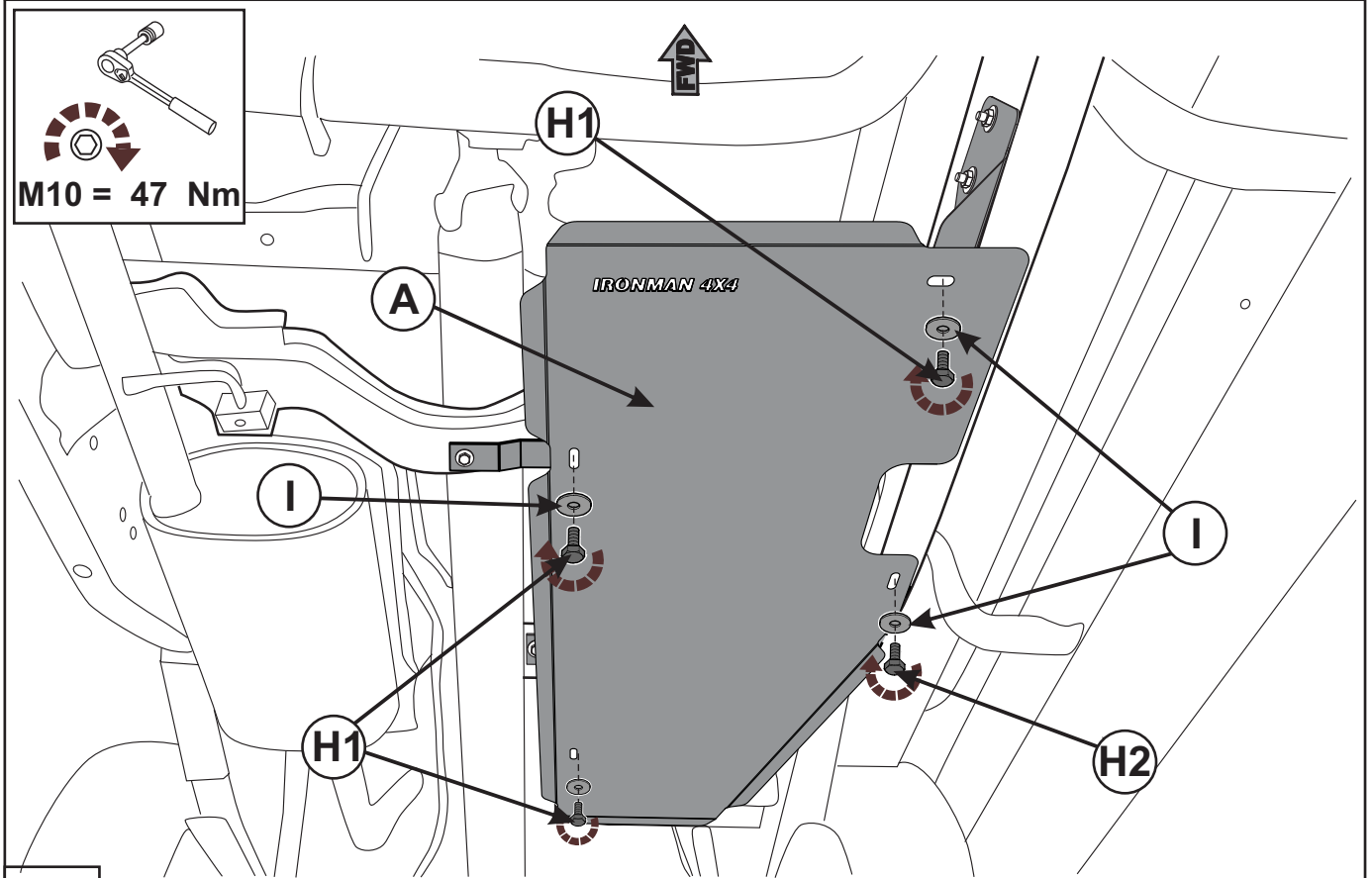

6



IUP007F

6/7

